

CDM

Double Suction Pump (Size : 200 to 1400m)



Performance Range

- Black Line - Pump Head
- Pink Line - Motor Rating in kW

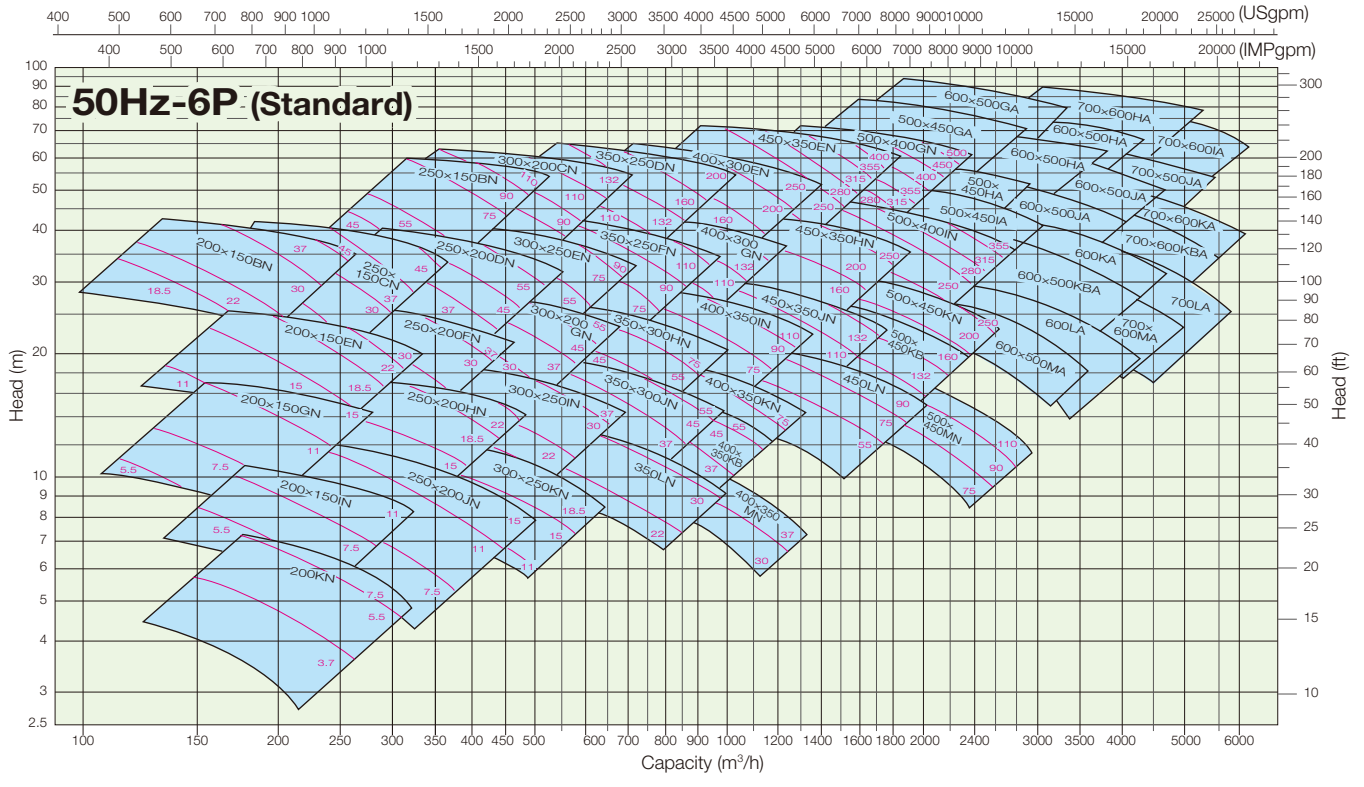
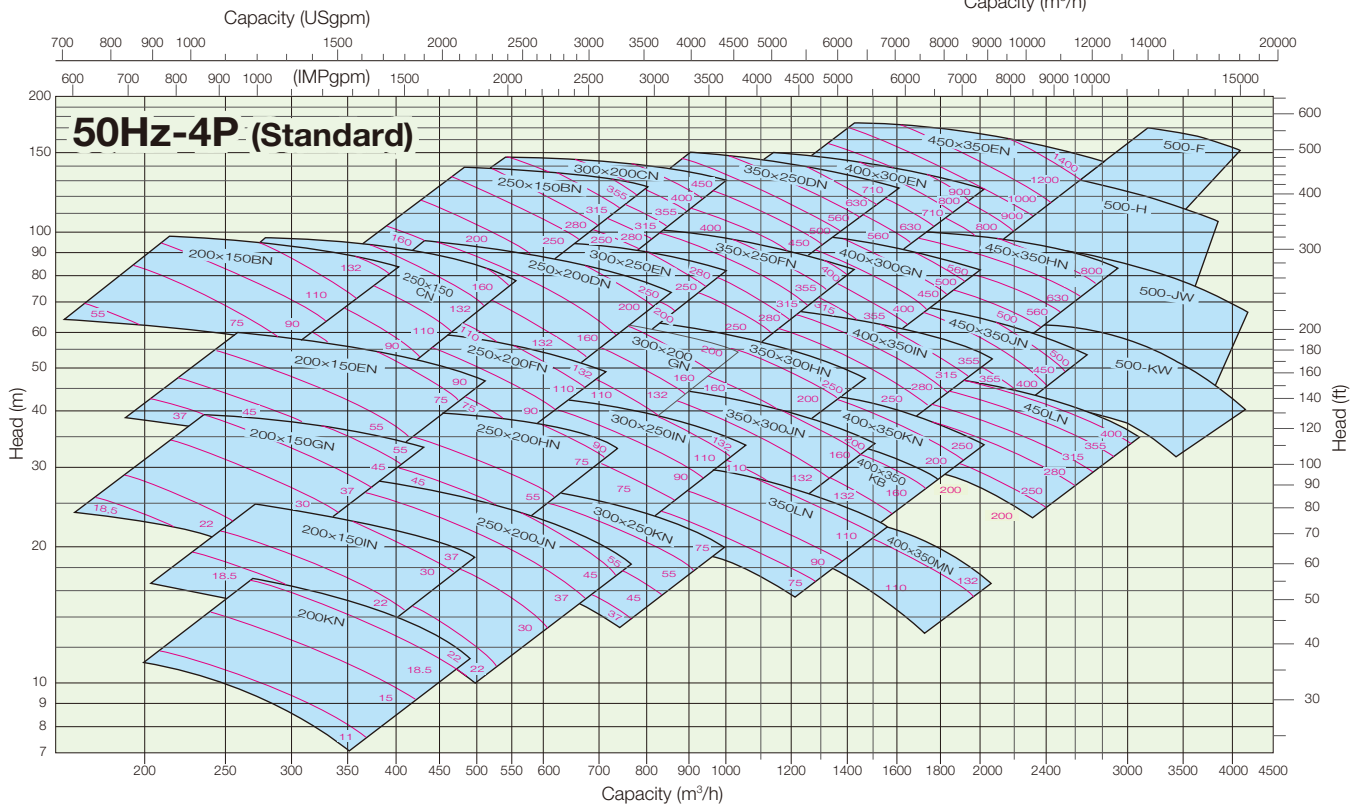
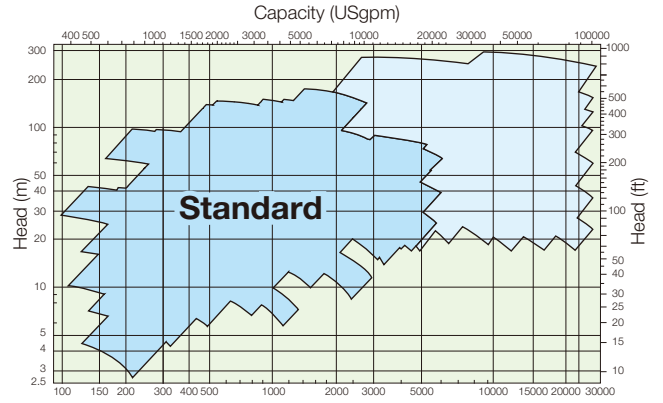

Performance Range

- Black Line - Pump Head
- Pink Line - Motor Rating in kW

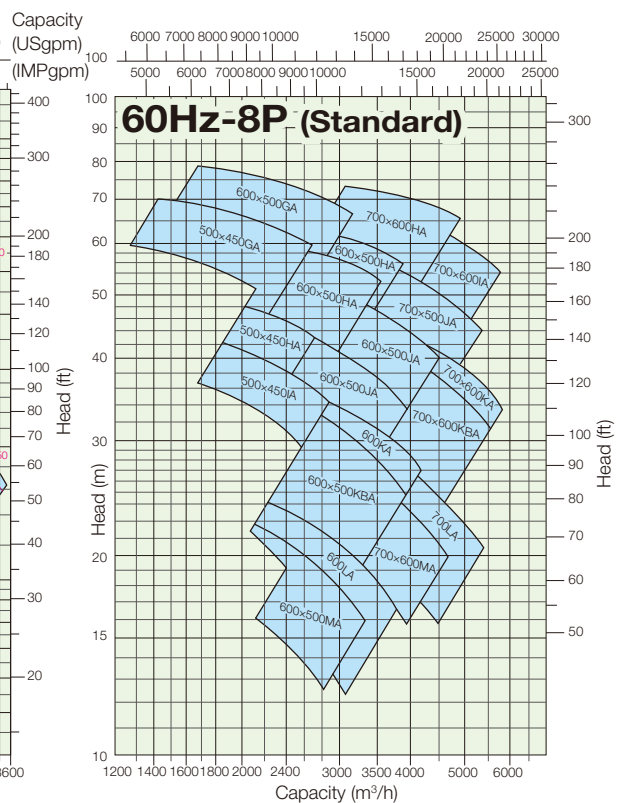
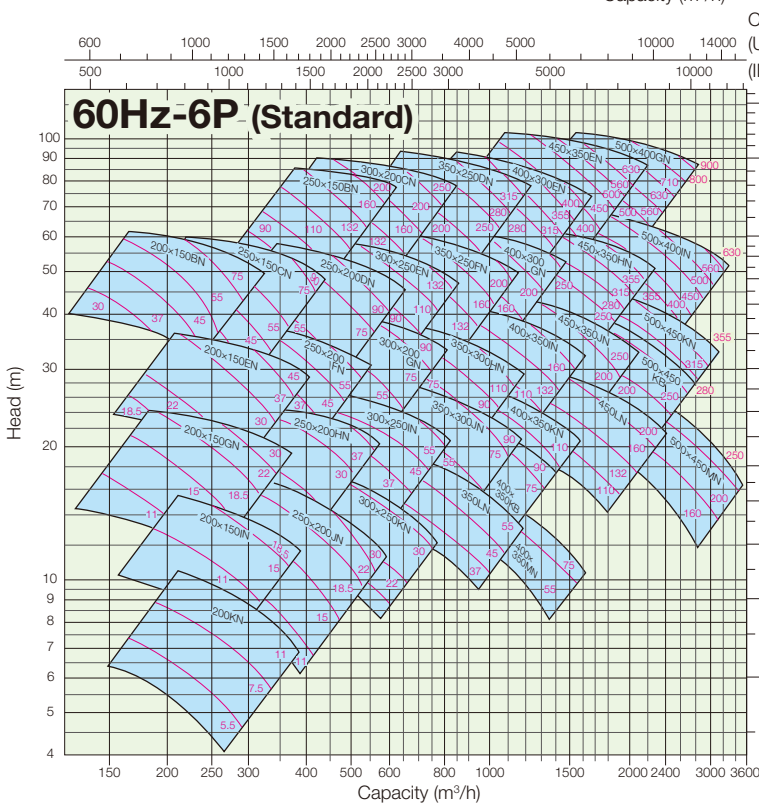
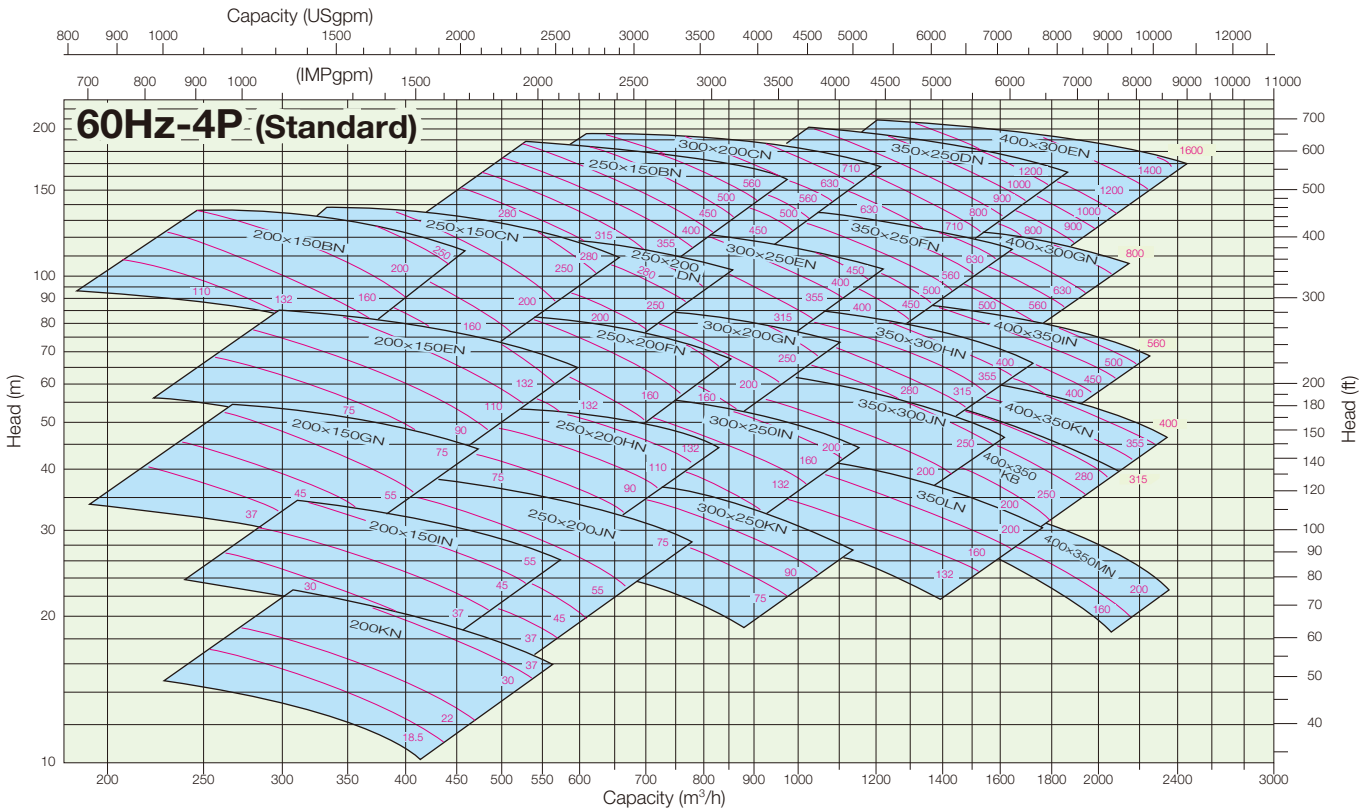
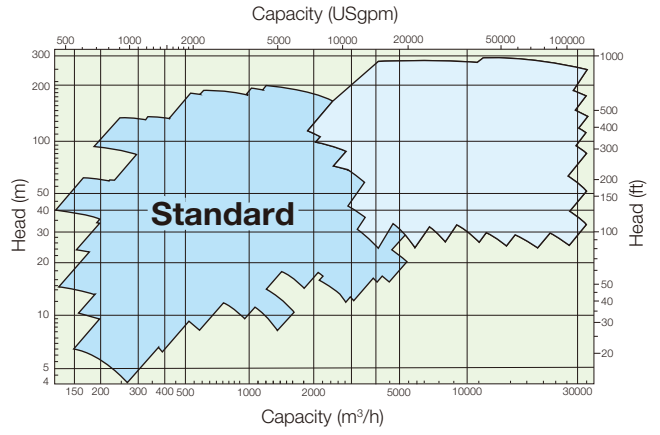

Torishima Pump Global Network



East Asia

- ① **Torishima Pump Mfg. Co., Ltd.** ■ ■
1-1-8 Miyata-cho, Takatsuki-city, Osaka 569-8660 Japan
Tel : +81-72-690-2308 / Fax : +81-72-690-2329
- ② **Kyushu Torishima Co., Ltd.** ■
9857-13, Ohaza Kawako, Wakagi-cho, Takeo-city, Saga 843-0151 Japan
Tel : +81-954-26-3081 / Fax : +81-954-26-3080
- ③ **Torishima Pump Mfg. Co., Ltd. Beijing Office**
Rm707, Building 1, KUNSHA CENTER, No.16 Xinyuanli, Chaoyang District, Beijing, P.R.China PC:100027
Tel : +86-10-84682891 / Fax : +86-10-84682890
- ④ **Torishima Pump (Tianjin) Co., Ltd.** ■ ■
No.9 Gaoxin Road, Wuqing Development Zone, Tianjin, P.R.China PC:301700
Tel : +86-22-59695601 / Fax : +86-22-59695609
- ⑤ **Torishima (Hong Kong) Ltd.**
Unit A, 21/F., Tower A, Billion Centre, 1 Wang Kwong Road, Kowloon Bay, Kowloon, Hong Kong
Tel : +852-2795-1838 / Fax : +852-2754-3293
- ⑥ **Torishima Service Solutions Formosa Co., Ltd.** ■
2F-1, No.99, Minfu St., Linkou Dist., New Taipei City 244, Taiwan
Tel : +886-2-26003381 / Fax: +886-2-26002986

South East Asia

- ⑦ **Torishima Pump Mfg. Co., Ltd. Singapore Office**
- ⑧ **Torishima Service Solutions Asia Pte. Ltd.** ■
60 Benoi Road #01-07 Singapore 629906
Tel : +65-6933-8772 / Fax : +65-6933-8777
- ⑨ **P.T. Torishima Guna Engineering** ■
- ⑩ **P.T. Torishima Guna Indonesia** ■
Jalan Rawa Sumur Timur No.1 Pulogadung Industrial Estate, P.O.Box 1160, Jakarta, Indonesia
Tel : +62-21-460-3963 / Fax : +62-21-460-3937
- ⑪ **P.T. Geteka Founindo** ■
JL Pulo Ayang Kav. AA2 Pulogadung Industrial Estate, P.O.Box 1160 JAT, Jakarta 13011 Indonesia
Tel : +62-21-460-3963 / Fax : +62-21-460-3937

- ⑫ **Torishima Service Solutions Asia Pte. Ltd. Philippines Office**
9/F Filinvest One Building, Alabang-Zapote Road, Filinvest City, Alabang, Muntinlupa City 1781 Philippines
Tel : +63-917-675-5225
- ⑬ **Torishima Service Solutions (Thailand) Ltd.** ■
181/2 Moo 1, Soi Bancha, Suksawad Road, Pakklong Bangplakod, Prasadutjedi, Samutprakarn 10290, Thailand
Tel : +66-2-408-3528 / FAX : +66-2-408-3529
- ⑭ **Torishima Service Solutions Asia Pte. Ltd. Vietnam Office**
52 Bui Thi Xuan Street, Hai Ba Trung District, Hanoi City, Republic Socialist of Vietnam
Tel : +84-4-3633-1446 / Fax : +84-4-3662-8555

South Asia

- ⑮ **Torishima Pumps (India) Pvt. Ltd.**
302 & 302A, 3rd Floor, Tower-B, Millennium Plaza, Sector27 Gurgaon-122002, Haryana, India
Tel : +91-124-4728950 / Fax : +91-124-4728950
- ⑯ **Torishima Pumps (India) Pvt. Ltd. Service Division** ■
Plot No. 27 B, C, D, Hoskote KIADB Industrial Area, Chokkahalli Village, Kasaba Hobli, Hoskote Taluk, Bengaluru-562114, Karnataka, India
Tel : +91-80-39581000 / Fax : +91-80-39581010

Oceania

- ⑰ **Torishima Australia Pty. Ltd.**
643-645 Glenhuntly Road, Caulfield South VIC 3162 Australia
Tel : +61-3-9523-7998

Middle East

- ⑱ **Torishima Service Solutions FZCO** ■
Plot of Land TP010501 National Industries Park (Techno Park)-Jebel Ali, PO Box. 37603 Dubai, U.A.E.
Tel : +971-4-880-7344 / Fax : +971-4-880-7354
- ⑲ **Torishima Pump Mfg. Co., Ltd. Middle East Project Office**
Office No.901, Deluxe Tower, Delma Street, Al Nahyan Camp Area, P.O.Box 53567, Abu Dhabi, U.A.E.
Tel : +971-2-674-3880 / Fax : +971-2-674-3881

- ⑳ **Torishima Pump Mfg. Co., Ltd. Qatar Project Office**
Office No.11,1st Floor, West Corner Centre, Salwa Road-Midmac R/A, P.O.Box 37027 Doha, Qatar
Tel : +974-4450-6915 / Fax : +974-4450-6916
- ㉑ **Torishima Service Solutions (Saudi Arabia) Ltd.** ■
Dammam, 2nd Industrial City, Road # 148- Cross # 81,PO Box 31952 Al Khobar, Kingdom of Saudi Arabia
Tel : +966-3-887-1500
- ㉒ **Torishima Pump Mfg.Co., Ltd. Saudi Arabia Representative Office**
Al Riyadh, Al Khair Plaza, Office No.2 Al Amir Muhd IBN A.A. Road, Althalea, SP-643351929, Kingdom of Saudi Arabia
Tel : +966-11-2931355

Europe

- ㉓ **Torishima Europe Ltd.**
Duart House, Finch Way, Strathclyde Business Park, Bellshill, North Lanarkshire ML4 3PR Scotland, U.K.
Tel : +44-1236-443951 / Fax : +44-1236-702875
- ㉔ **Torishima Service Solutions Europe Ltd.** ■
Unit 3, M8 Interlink, Kirkshaws Road, Coatbridge ML5 4RP Scotland, U.K.
Tel : +44-1236-442390 / Fax : +44-1236-702875
- ㉕ **Torishima Europe Ltd. Madrid Office**
Avda. Fuente Nueva 12A, 28703San Sebastian de los Reyes, Madrid, Spain
Tel : +34-91-002-7541 / Fax : +34-91-284-6901

North America

- ㉖ **Torishima Pump Mfg. Co., Ltd. North America East Office**
100 Grove Street, Suite 217, Worcester MA 01605-2654 U.S.A.
Tel : +1-508-753-6600 / Fax : +1-508-753-8276

Central America

- ㉗ **Torishima Europe Ltd. Mexico Office**
Plateros No.58A, Fracc La Concordia, Lomas Verdes 5a Sección, Naucalpan de Juarez, Estado de México. C.P. 53120
Tel : +52-1-55-51935-4311

■ Manufacturing ■ Service Center